

# T4S

T4.55S | T4.65S | T4.75S





# New Holland Services.



## Finance tailored to your business

CNH Industrial Capital, the financial services company of New Holland, is well established and respected within the agricultural sector. Advice and finance packages tailored to your specific needs are available. With CNH Industrial Capital, you have the peace of mind that comes from dealing with a financing company that specialises in agriculture.



## Trained to give you the best support

Your dedicated New Holland dealer technicians receive regular training updates. These are carried out both through on-line courses as well as intensive classroom sessions. This advanced approach ensures your dealer will always have the skills needed to look after the latest and most advanced New Holland products.



## Looking after your investment

New Holland Original Parts are the only parts that fully meet the quality requirements essential for the cost-effective operation of your New Holland machine. This is because the engineers who design those parts and supervise their production are the same people who are responsible for developing our products. So, they know exactly what's right for your machine.

# New Holland T4S tractors. Simply modern.

New Holland T4S 55 hp to 75hp tractors deliver the perfect balance between modern efficiency and the demands for a simple tractor that just does exactly what you need. Four-wheel drive delivers added traction for even greater versatility. Need a cab? T4S tractors are offered with a new generation four-post cab that delivers the best all round visibility and operator environment in this tractor class. Available with mechanical 8x8 (T4.55S and T4.65S) or 12x12 transmissions (T4.75S), a T4S offers the specification choice to suit farmyard, or field, hobby farm or hay and forage enterprises. Need a loader? Loader work is a breeze with a hydro-mechanical shuttle standard for clutch free changes between forward and reverse. A quality quick-hitch, quick release loader is standard with impressive cycle times. Do you work with rear mounted equipment? With a T4S you can benefit from class leading performance with Lift-O-Matic linkage control as standard. Servo assisted PTO engagement, with an easy to modulate soft start, comes as part of a tractor that is built to meet modern demands for efficiency and ease of operation with traditional simplicity and ease of maintenance.

## Ease of ownership

T4S tractors are designed for hard work. All daily maintenance checks are quick and easy to make which means you'll spend more time doing what a T4S does best: working. Want more? How about fuel efficient, turbo intercooled engines compliant to Tier III emissions standards. An easy to maintain 'powercore' air filter takes care of the extra dust thrown up by loader work - an often overlooked consideration.

## Absolute driving pleasure

The new generation four-post cab with a high comfort suspended seat, puts the operator in comfortable control. T4S cab tractors set new standards in this tractor class, with panoramic visibility of all implements. Powerful heating and air conditioning keeps you comfortable in all seasons.

## Versatility

Compact and capable, with the hydraulic power shuttle transmission to suit loader and maneuverability needs, a T4S can be your one tractor solution. It is equally at home performing loader work in the yard to working a wide range of attachments in the paddock, park or taming a bush block. The T4S delivers versatility as standard.

## Power and productivity

The smooth running S8000 series engine packs an efficient and reliable power punch of up to 75hp with outstanding fuel economy and impressive torque characteristics. Offering the ideal balance between power, weight and size, a T4S is designed to offer dependable performance across a wide range of tasks. It is the power and productivity choice for small farms and dairy units, with a specification to suit applications as diverse as municipal works to estate and contract operations.



## The label on the bonnet says it all

New Holland makes it simple to identify the power of its tractors. With T4S models, the '4' refers to the tractor series, 'S' representing simplicity of design. As to the numbers, T4.55S, T4.65S and T4.75S, deliver 55, 65 and 75hp.

Model	Rated hp(CV)	Wheelbase 4WD mm	Weight 4WD kg
T4.55S	55	2123	3100
T4.65S	65	2123	3100
T4.75S	75	2123	3100



# New generation cab. We put you in comfortable control.

---

## Simplicity meets modern thinking

Take the time to look over a New Holland T4S tractor and you will see for yourself that these tractors offer the perfect balance between traditional tractor design and modern ergonomics. New users will quickly feel comfortable and appreciate the easy reach of everything they need to work the tractor safely and efficiently. With the new generation cab, we take this class of tractor to a new level. With its four-post design, and pillar to post glazing, the cab gives superb all-round visibility. An opening glazed roof panel is functional too, allowing loader equipped tractors to be positioned with pin point accuracy. Highly efficient heating and ventilation, with air-conditioning as standard, ensures the operator remains comfortable, whatever the weather.

## Quiet. Comfortable. Spacious.

The new generation cab of the T4S tractors has a flat floor to eliminate the bulk of a transmission tunnel, making it more spacious. Wide door openings to ensure it is easy to access the comfortable interior and a choice of mechanical or air suspension seat guarantee a comfortable ride. The heating and ventilation package is powerful, keeping the cab mist free in winter and super cool in summer. Low noise levels reduce fatigue and a powerful lighting package lights the darkest nights. With a T4S tractor you get big tractor cab features in a small tractor package.





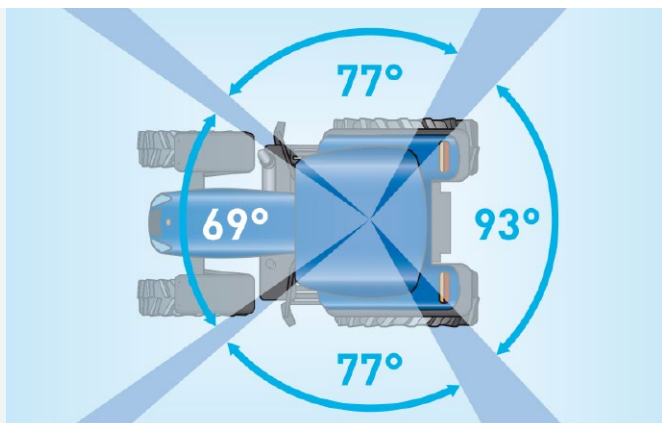

### True all-round visibility

When we describe the new generation cab as offering true all-round visibility, we are not exaggerating. Thanks to the four-pillar cab design, the view from the operator's seat is panoramic. In tight spaces or when working in the field, good visibility is a valuable aid to productivity. See more, do more.



### See beyond the roof line

- All cab models all have a high visibility roof panel to offer a perfect view and provide a bright and airy environment.
- The roof panel can be opened for extra ventilation and features a retractable sun blind.



### Cab roof lighting package

- With a T4S, four integrated cab roof lights can deliver the extra illumination you need, stretching out into the darker recesses of buildings or helping you spot the last bales in a paddock.



### Bluetooth Radio

- Radios are Bluetooth and equipped with a USB port as standard.
- Talk hands free or listen to your own music.



### Loader operators – we think of you too

The standard Challenge AP30 Plus loader sits low and tight to the hood line to provide an excellent field of vision out over the front and sides.

### FOPS: for peace of mind

- The new generation T4S cab model range offer FOPS (falling object protection system) technology as standard.



# Don't confuse simple with basic.

---

## **We work on the ergonomics. You concentrate on the job.**

Over 20 years ago, New Holland raised the bar in small tractor design with its TN tractor series. From the outset, these 'new generation' small tractors were built around the needs of the operator, with extensive research establishing the best position for all key controls. TN tractors set a new benchmark in establishing the ideal relationship between the operator and the tractor.

From those original ideas, T4S tractors benefit from further developments in modern tractor design. A T4S may be simple but that should not be confused with basic. Every penny of our research is invested to make you and our tractors more productive.

Quality of design is matched in quality of production. Everything you touch has a solid quality feel to it. All materials are designed to withstand the rigours of a hard life. You invest in New Holland. We invest in delivering high quality in design and build.





### Simplicity takes good design

- Transmission levers, hand throttle, remote valve controls, rear linkage raise-lower, Lift-O-Matic™, PTO and electric switches are grouped exactly where you would expect them to be.
- Simplified controls help deliver safe levels of high productivity throughout the working day.



### Integrated loader joystick exactly where you want it

- T4S loader ready also includes a joystick control positioned just where you need it, with integrated functions to deliver seamless loader operation.



### True PTO control

- Mounted within the left hand console, the PTO engagement lever is exactly where the operator would want it.
- The PTO levers light action ensures easy modulation of power to the attachment.



### Adjustable steering column

- The ideal driving position can be easily achieved thanks to the tilting steering column, activated by a convenient foot pedal.



# Clean, powerful, productive.

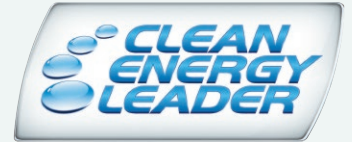

*Sustainable Efficient Technology*

Purposed developed for intensive agricultural use, the three-cylinder S8000 engine series that power T4S tractors offers unrivalled power, torque and economy. These proven power units offer the rugged, long lived dependability small tractor operators demand from their investment. In work, the engines are smooth and quiet, with maximum torque developed at just 1400rpm, to ensure fast responsiveness when a sudden load is encountered, and fuel efficiency is guaranteed at lower engine speeds. Torque rise on the T4S engine is also impressive, ensuring rapid recovery when the going gets tough and avoiding the need to change down gears in applications such as power harrowing and transport.





### The right power for your needs

The right tractor is the one that has the performance you need, not the excess power you will never exploit. With T4S, the choice of 55, 65 and 75hp has been chosen as it reflects the applications these tractors are designed for. Around the yards or paddock, choose the power for your specific demands.

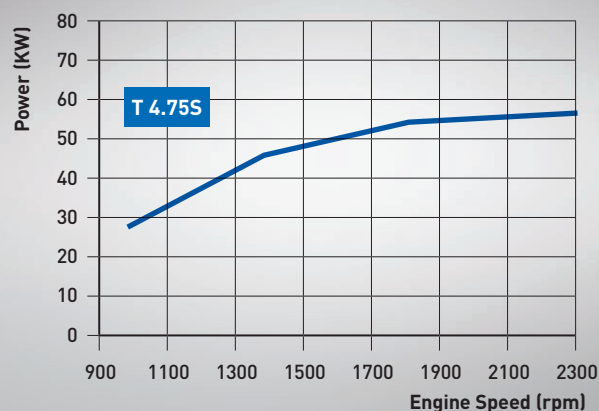

### Impressive torque back up

Some power units can fail to deliver consistent performance in extreme conditions. Not with T4S. Fitted with the latest generation of turbochargers with powerful intercoolers, S8000 power units benefit from a constant flow of cooled air for enhanced combustion efficiency, regardless of temperature and deliver impressive torque rise figures of up to 32%.

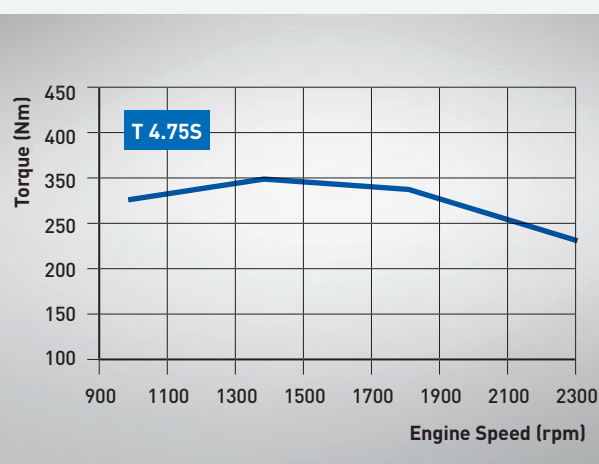

### Easy servicing

T4S tractors are built to reduce whole-life operating costs. Daily service checks can be carried out quickly, making a T4S easy to keep at peak operating efficiency.



### Ready for work, from the turn of the key

The compact design of three-cylinder S8000 engines brings benefits. Not only does the short engine block reduce the overall length of a T4S, the compact design warms up quickly, ensuring the engine reaches its peak operating temperature in a short time.

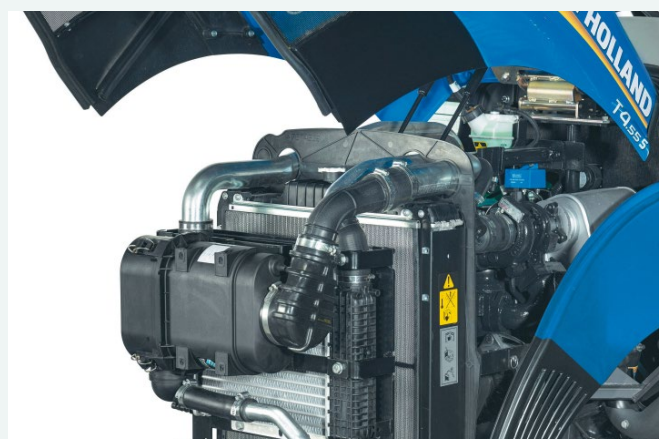



## Front End Loader: Quality as Standard

---

You will see an AP30 Plus Challenge loader up front on the whole T4S range. Regarded for their suitability to tough Australian conditions these have been designed specifically for the T4.55S, T4.65S & T4.75S to ensure proper tractor and loader integration, optimal performance and just the right features and options.

Quality has never been a compromise and the New Holland AP Plus Series loaders have stood the test of time and provide customers with a front-end loader range that meets performance challenges front-on.





### Excellent Visibility

The standard Challenge AP30 Plus loader sits low and tight to the hood line to provide an excellent field of vision out over the front and sides. The horizontal exhaust exit removes the risk of damage and means no interruption to the operator's line of sight.



### Up high

The HiVis panel ensures a clear view of the loader bucket or attachment when fully raised for dumping into a mixer or stacking that last bale.



### Durability by design

The AP30 Plus is a mechanical self-levelling configuration with a quick detach design using patented Challenge camlock locating pins. Support rails mount to both the bellhousing and front tombstone for maximum strength. The AP30 Plus also features a cross support to dissipate torsional flex under heavy conditions.



### Here's the hitch

The integrated loader joystick has been designed to be more ergonomic providing the operator the choice to grab the top of the joystick for traditional operation or to grab around the joystick for a more modern and ergonomic approach.

Euro or AUS style quick attach system available. No need to change from your current hitch system. Prepare to engage: choose a versatile 4 in 1 MLCM 1860mm Bucket or GP MLC 1860mm Bucket for optimum functionality and farm efficiency.



# Proven mechanical simplicity.

A key to versatile performance is having the right transmission speed for the application. With T4S tractors, there are two gearbox configurations; dual range 8x8, for the T4.55S and T4.65S and three range 12 x 12 for the T4.75S. All transmissions share the same proven four synchromesh speeds in each range for easy on the move gear changes. A theoretical top speed of 40 Kp/h is applicable to the T4.75S transmission. Befitting the extra power, this transmission is perfect for utilising the 75hp's superior torque at low groundspeeds.

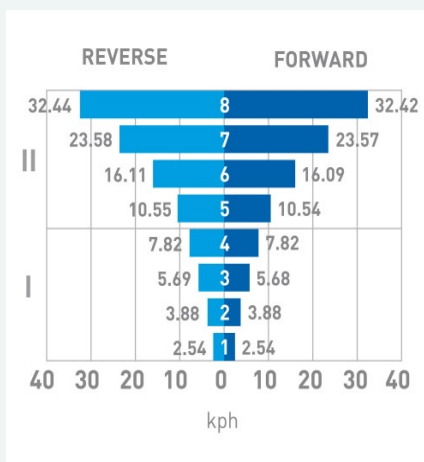

## Two working ranges

- Ideally suited to small farm and dairy unit demands, the T4.55S and T4.65S utilise an 8x8 transmission which offers a broad speed selection.
- Split into two ranges, with four speeds in each, the operator uses the foot clutch to change speeds on-the-go. The steering column mounted direction lever selects forward or reverse without using the foot clutch.

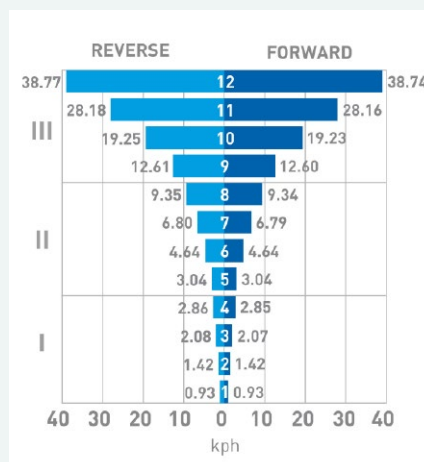

## Three ranges, twelve working speeds

- Applications calling for more power and a broader range of speeds have the 12x12 transmission as standard on the T4.75S.
- Featuring four speeds in each of the three working ranges, this transmission retains the traditional 'H' shift pattern and column mounted direction lever across the T4S range.

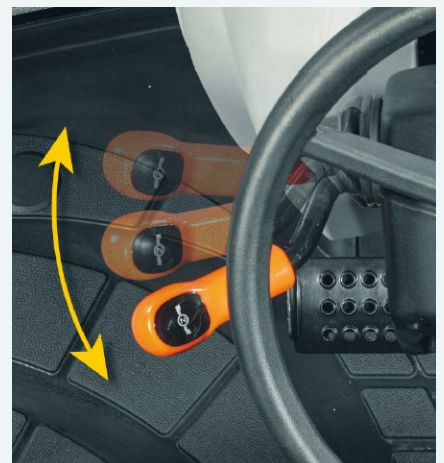

## Loader friendly powershuttle

- T4S models are offered with a column mounted hydraulic powershuttle.
- For front loader applications or speedy headland turns, the hydraulic powershuttle really boosts productivity.



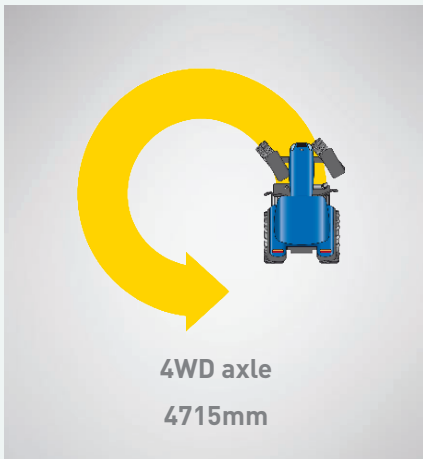

#### Four-wheel drive traction

- Four-wheel drive models feature an un-braked turn radius of just 4.7m.
- Fitted with a limited slip differential, a T4S delivers traction when you need it and brilliant agility when you don't.
- Electro-hydraulic engaged rear differential lock comes as standard.



#### Wheel and Tyre offering

- T4.55S and T4.65S come with 20" fronts and 28" rear wheel equipment. The front is a Heavy-duty type suited to the demands of the loader.
- T4.75S has 24" fronts and 30" rear wheel equipment as standard, befitting a specification that can be used for more specialised traction demands.

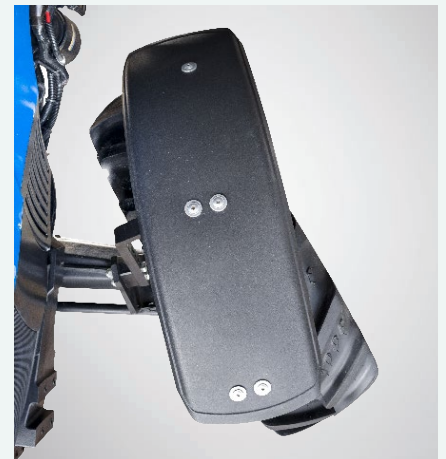

#### Dynamic front fenders\*

- Steering angle is maximized thanks to the dynamic front fenders optional on 4WD models.
- A spring mechanism prevents the fenders touching the tractor chassis, but allows the wheel to continue to its maximum lock.

\*Not available with Loader



# Simply versatile.

With a rear linkage capacity of up to 1,950kg, a T4S tractor has the muscle to work with a wide range of fully mounted equipment, enabling these versatile tractors to tackle duties beyond the scope of competitive tractors of similar power. Next add a powerful hydraulic flow of up to 47.7 litres/min and two mid mount valves. Add the choice of up to three rear remote valves. Now add a servo assisted 540/540E PTO. A T4S may be simple but it is by no means basic.



## Lift-O-Matic™ for speedy turns

With a T4S tractor, you get the proven benefits of Lift-O-Matic. Proven over many generations of New Holland tractors, Lift-O-Matic offers fingertip fast raise and lower of implements to a pre-set position. During a headland turn, all you do is flip a switch to raise the rear linkage to a pre-set maximum height and at the headlands, do the same again to lower the links to your chosen setting.



## Economy PTO speed

The direct drive PTO system reduces power losses from the engine and the number of wearing parts within the transmission for increased productivity and reliability. Activated by a dedicated in-cab lever featuring soft start engagement, the PTO clutch allows the operator to feed power to a driven implement gradually. Two PTO speeds are available, 540 and 540 ECO.



## Strong and easy to adjust

The rear linkage of T4S tractors follows proven New Holland design, with telescopic sway bar adjustment for the lower link arms, adjustable lift rods and quick attach couplers. Subjected to a stringent testing and rigorous quality control process, the CAT II rear linkage has a maximum lift capacity of 2700kg\* to work with the heaviest rear mounted implements.

\* with Aux lift cylinder

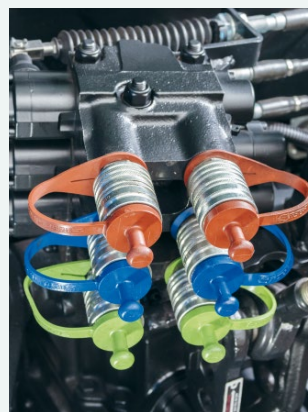

## Three rear remotes

Up to three rear remotes can be specified and benefit from a hydraulic pump output of 47.7l/min, independent of the steering circuit. Two rear remotes are standard.

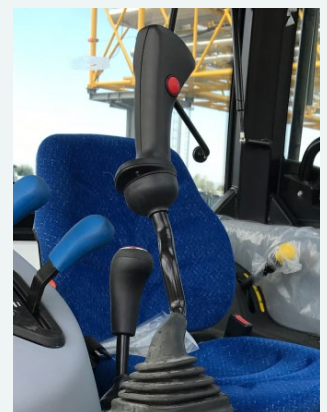

## Mid mount remotes.

The loader package includes two mid-mount remote valves controlled via the ergonomically positioned joystick. This will enable a T4S to operate a range of specialist attachments to include front mounted equipment such as an optional 4 in 1 Bucket.



Models	T4.55S	T4.65S	T4.75S
<b>Engine</b>			
Capacity litres	2.9 Litre		
Number of cylinders / Aspiration	3 Cylinder / Turbo Intercooled		
Rated engine hp @ 2300 rpm	55	65	75
Fuel capacity	82 Litres		
<b>Transmission</b>			
8 x 8 power shuttle (30kph)	●	●	
12 x 12 power shuttle (40kph)			●
<b>Standard front axle</b>			
4WD standard axle	Standard		
Maximum steering angle (degrees)	45		
<b>PTO</b>			
540 / 540E rear PTO	Standard		
<b>Operator environment cab</b>			
4 pillar cab with air conditioning & heating	Standard		
High visibility loader panel	Standard		
Cab noise level	83 dB(a)		
Flat floor	Standard		
Suspension seat c/- with belt & armrest	Standard		
Tilt steering column	Standard		
Radio w/Bluetooth	Standard		
<b>Electrical</b>			
Alternator (amp)	120		
Rotary beacon	Standard		
<b>Hydraulic system</b>			
Twin gear pump with open centre system	Standard		
Hydraulic pump flow	47.7 L/min		
Independent steering pump flow	29.0 L/min		
Total pump flow (inc steering)	76.7 L/min		
Rear remote valves	2 Standard / 3rd optional		
2 mid mount remote valves c/- joystick	Standard		
<b>3 Point linkage</b>			
Mechanical draft control	Standard		
Lift-O-Matic™	Standard		
Maximum lift capacity	1950 kg @ 610mm behind ball ends		

Loader	T4.55S	T4.65S	T4.75S
Model	AP30 Plus NH MSL loader		
<b>Dimensions and Angles</b>			
Maximum Lift Height @ Pivot Pin (mm)	3100		
Maximum Lift Height with Level bucket (mm)	2810		
Dump Clearance at 45° (mm)	2470		
Dump Clearance at dump angle (mm)	2260		
Digging Depth (mm)	155		
Reach @ ground level (mm)	2000		
Bucket rollback angle	49°		
Weight kg	416		
<b>ATTACHMENTS &amp; ACCESSORIES 4 in 1 Bucket (GP Bucket optional)</b>			
Model	186MLCM		
Description	Midsize		
Width	1860mm		
Weight	235kg		
Struck capacity	0.25m³		
Rated capacity	0.32m³		
<b>Operating Parameters</b>			
ROL(kg)	480		
With recommended Counterweight ballast(kg)	540		
<b>Hitch</b>			
AUS	Optional		
EURO	Optional		

# NEW HOLLAND. A REAL SPECIALIST IN YOUR AGRICULTURAL BUSINESS.



AT YOUR OWN DEALER



**YOUR SUCCESS – OUR SPECIALTY**

Visit our web site at: [www.newholland.com](http://www.newholland.com) - tel: +61 2 9673 7777  
31-53 Kurrajong Road, St Marys NSW 2760



Safety begins with a thorough understanding of the equipment. Always make sure you and your operators read the Operator's Manual before using the equipment. Pay close attention to all safety and operating decals and never operate machinery without all shields, protective devices and structures in place.

The data indicated in this folder are approximate. The models described here can be subjected to modifications without any notice by the manufacturer. The drawings and photos may refer to equipment that is either optional or intended for other countries. Please apply to our Sales Network for any further information. Published by New Holland Brand Communications. - Printed in Australia - 170014/INB